

audiopraise

Vanity<sup>PRO</sup>

# *User Manual*



Valid for firmware version v5

## Table of Contents

1	Introduction.....	4
1.1	HDMI Audio.....	4
1.2	VanityPRO.....	4
2	Description .....	5
2.1	Front.....	5
2.2	Back.....	5
2.3	Output Boards.....	6
3	User Interface.....	6
4	Installation.....	7
4.1	AV Signals.....	7
4.2	Power.....	7
4.3	Synchronization Clocks.....	8
5	Theory of Operation.....	8
5.1	Block diagram.....	8
5.2	HDMI Extractor.....	8
5.3	Clock Recovery and Jitter Reduction.....	9
5.4	DSD Processing Engine .....	10
5.4.1	DSD to PCM Conversion.....	10
5.4.2	DSD and PCM Level Matching.....	10
5.4.3	DoP v1 output mode.....	10
5.5	Down-Mix .....	10
5.5.1	7.1 to 4.0.....	10
5.5.2	7.1 to 2.0.....	11
5.6	Volume Control.....	11
5.7	EDID Control.....	11
5.8	Dielectric Barrier.....	12
5.9	Firmware Upgrades.....	12
6	Menu system.....	13
6.1	Home Screen.....	13
6.2	Audio Setup.....	14
6.2.1	Filters Characteristics.....	15
6.3	Speaker Setup .....	17
6.4	Speaker Trim Setup.....	18
6.5	HDMI Setup.....	19
6.6	EDID Setup.....	20
6.7	System Setup.....	21

6.8	HDMI AV Info.....	22
6.9	Audio Meters.....	23
6.10	System Status.....	24
7	Software Update.....	25
8	Troubleshooting.....	26
9	Specifications.....	27
10	Revision History.....	28
11	Disclaimer .....	29

# 1 Introduction

The Vanity<sup>PRO</sup> is a multi-channel HDMI digital audio extractor with advanced signal processing built in. It enables the user to turn virtually any compatible HDMI source into a high-quality, up to eight-channel digital audio transport which supports PCM and DSD audio formats.

## 1.1 HDMI Audio

HDMI is the primary method of transporting AV signals in the consumer environment. It works great with high resolution audio and video, but it has never found its way into the hi-fi world.

Apart from some non-technical reasons, one of the biggest issues associated with HDMI audio is quality of the clock recovered from the HDMI stream and electrical noise associated with it. Despite many improvements in the newest HDMI receiver devices, the recovered clock always suffers from high levels of phase noise. While this is usually not an issue in consumer audio – home theatres, sound bars, etc., in the discipline of critical listening the imperfections of HDMI audio are instantly noticeable. Also, HDMI audio is notoriously known to be sensitive to various forms of electro-magnetic interference, cabling quality, ground loops and in the hi-fi world generally considered as inferior when compared to dedicated digital audio transport methods such as SPDIF, AES/EBU or proprietary links based on the I2S bus.

There is usually nothing wrong with the audio data itself, provided the receiver can take advantage of all the digital formats and sampling rates available on the source side. What can cause issues is mainly the way the audio data is packed and interleaved with the video data in a high frequency digital signal and eventually recovered on the HDMI receiver (sink) side. There are many cheap HDMI audio extractors on the market, and some of them being able to output digital audio via S/PDIF up to 192kHz sampling rate. But they still don't come even close to a good digital transport in terms of audio quality.

## 1.2 Vanity<sup>PRO</sup>

How is the Vanity<sup>PRO</sup> different from all the other HDMI audio extractors? It basically addresses all the imperfections associated with the HDMI audio, one by one, with a ton of extra features the others don't have.

- Galvanically isolated HDMI interface from the sensitive audio output circuitry with separate power connections.
- Ability to receive PCM and DSD formats at all sampling rates (PCM up to 192kHz).
- Sophisticated clock recovery using our in-house developed DBLL (Digital Buffer Locked Loop) system with two custom-made low noise oscillators.
- High quality DSD to PCM conversion with user configurable parameters.
- DSD to DoP conversion for raw DSD data output.
- Up to 8-channel support.
- Ultra-low noise regulators for the clocks and digital audio outputs.
- HDMI link monitoring and diagnostics.
- Configurable output connectivity for stereo and multi-channel setups.
- Multichannel processing – Downmix, speaker trim, volume control
- ARC and CEC functionality

## 2 Description

### 2.1 Front



- 1) RGB LCD 320\*240 Screen
- 2) Stand-by and Status LED Indicator
- 3) Rotary Encoder with Push-button

### 2.2 Back



- 1) HDMI DC Power Input, 5V/1A, USB-C
- 2) HDMI Output
- 3) HDMI Input
- 4) Digital Audio Output Board (Stereo board shown)
- 5) Word-Clock Output (44.1kHz to 192kHz)
- 6) Super-Clock Output (22.5792MHz or 24.576MHz)
- 7) Service Port, USB-B
- 8) Audio DC Power Input, 5V/1A, USB-C

## 2.3 Output Boards

For maximum flexibility, the Vanity<sup>PRO</sup> features an interchangeable output module with various configurations of the output connectors. There are 4 options in total, covering 1 stereo and 3 multichannel configurations with RCA, BNC and XLR connectors.



Stereo output Board

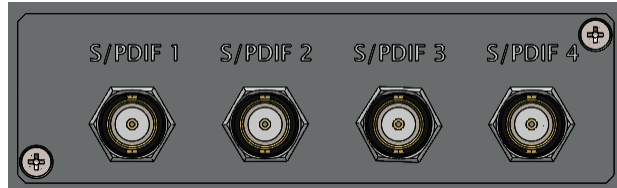

BNC Multi-channel Output Board

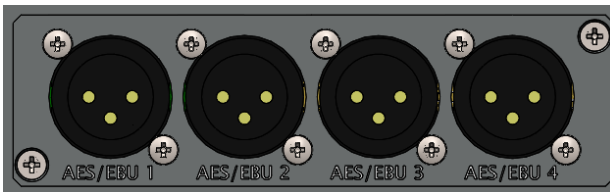

XLR Multi-channel Output Board



RCA Multi-channel Output Board

## 3 User Interface

The unit is operated using a rotary encoder with a push-button function and an LCD screen. The navigation is easy through a series of screens with options and metering & diagnostic data.

- Turning the rotary encoder left and right changes the screen, moves between options in a configuration menu or selects from multiple options.
- Pushing the knob in one of the two configuration screens will enter the sub-menus.

A screenshot of the LCD screen displaying "DSD to PCM:" at the top and "Sampling Rate 176k" below it. The text is white on a dark blue background.

- Pushing the knob with an item highlighted will enter the item configuration.

A screenshot of the LCD screen displaying "DSD to PCM:" at the top and "Sampling Rate 176k" below it. A small white left-pointing arrow is visible to the right of the "176k" value.

- Once the correct option is selected by turning the knob left and right, pushing the knob again will confirm the selection and return into the menu.

A screenshot of the LCD screen displaying "DSD to PCM:" at the top and "Sampling Rate 88k" below it. A small white left-pointing arrow is visible to the right of the "88k" value.

- To exit the menu and go back to the screen selection, long (2 seconds) push of the knob is required.
- The knob is also used to toggle between stand-by and normal operation of the unit. Long push the knob to turn the unit on from the stand-by mode. Long push the knob in the home screen to enter stand-by mode.

## 4 Installation

### 4.1 AV Signals

The typical installation of the Vanity<sup>PRO</sup> consists of a HDMI signal source capable of delivering all compatible digital audio formats and sampling rates, such as a universal player or a PC and a stereo/multi-channel DAC or audio processor, that can take advantage of the high-quality and high-resolution S/PDIF or AES/EBU signals. Optionally, the user can connect a HDMI sink such as a TV or a projector to the HDMI output of the Vanity<sup>PRO</sup> for video pass-through.

The HDMI connectors are quite delicate and should be plugged and unplugged carefully without excessive force or wiggling to prevent damage. The same applies to the power USB-C connectors.

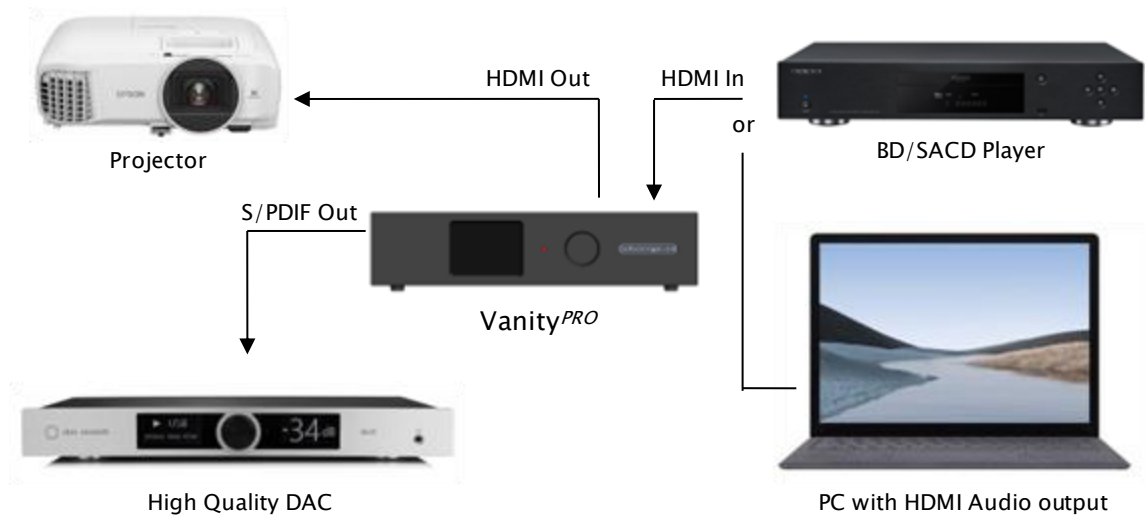

Typical signal connections of the Vanity<sup>PRO</sup>

### 4.2 Power

The Vanity<sup>PRO</sup> has two independent power inputs. One for the HDMI part, one for the audio part. The power supplies must meet the voltage and current requirements (see specifications).

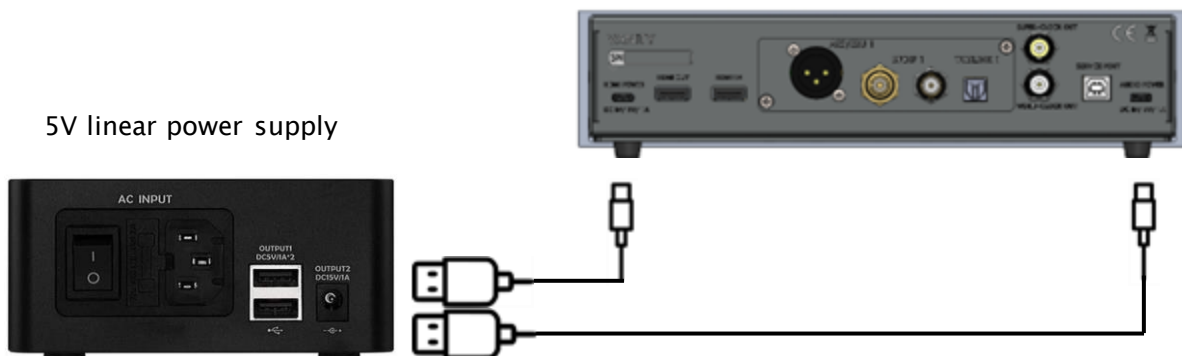

Power connection of the Vanity<sup>PRO</sup>

It is strongly recommended to use high quality 5V power supplies, ideally linearly regulated. Alternatively, multi-port premium and low noise USB chargers can be used. The power quality directly influences the quality of the output audio signal. Therefore, high quality power supplies are essential.

Both parts of the unit can be powered independently. The HDMI part is capable of working on its own without the audio and control part powered up.

### 4.3 Synchronization Clocks

There are two synchronization clock outputs provided on BNC connector with 50Ω output impedance. The purpose of these two clock outputs is to synchronize any downstream audio devices such as a DAC equipped with a synchronization clock input. The advantage of external synchronization is usually in better and cleaner clock signal available for the digital to analogue conversion process compared to a clock recovered from a S/PDIF or AES/EBU stream.

There are “Word Clock” and “Super Clock” signals provided. The Word Clock is a sampling frequency clock  $F_s$ , while the Super Clock is either 22.5792MHz or 24.576MHz.

## 5 Theory of Operation

### 5.1 Block diagram

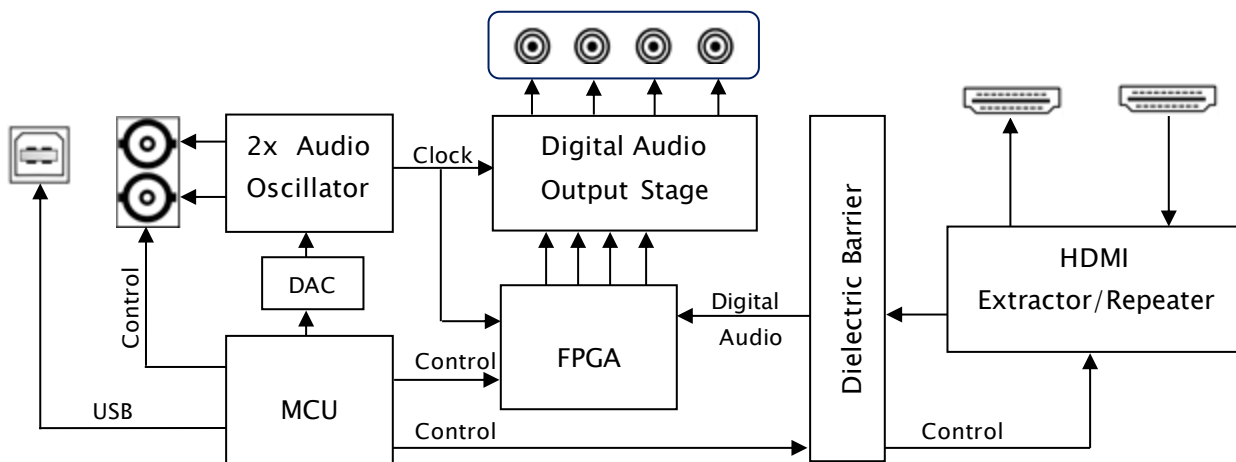

Block Diagram of the Vanity<sup>PRO</sup> showing the main digital audio and control signals

### 5.2 HDMI Extractor

The HDMI interface has combined functionality of a HDMI extractor as well as a repeater. The main difference between both modes is in handling the EDID data. While in the extractor mode (default), full audio capabilities in terms of formats (PCM/DSD) and sampling rates are reported back to the HDMI source, the repeater mode passes through the EDID information from the connected downstream HDMI sink (TV or projector). The other difference is that in the extractor mode the audio data are removed from the output HDMI stream and only video part of the original stream is passed through.



### 5.3 Clock Recovery and Jitter Reduction

To deal with one of the major technical imperfections of the HDMI interface, the Vanity<sup>PRO</sup> uses a pair of low-jitter digitally controlled oscillators and an adaptive control algorithm to lock onto the incoming audio frequency and output the audio data with perfect timing, completely free of any jitter or noise of the HDMI interface.

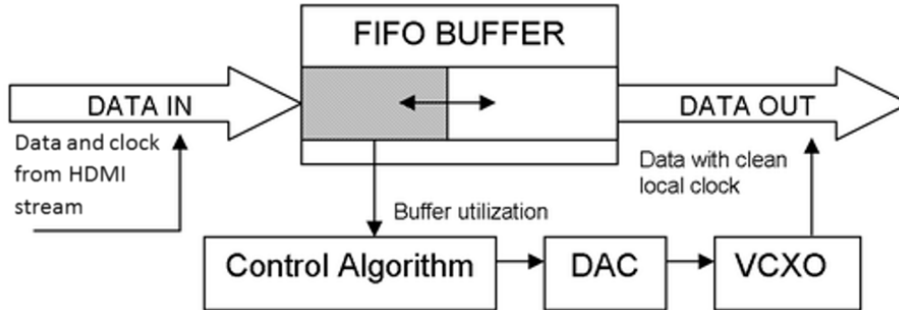

Block diagram of the clock recovery system

Audio data from the HDMI interface is buffered in FIFO memory and clocked out with local high precision oscillators. As a result, the output signal is completely isolated from the noisy HDMI domain – interferences from the power supplies, video circuits, etc.

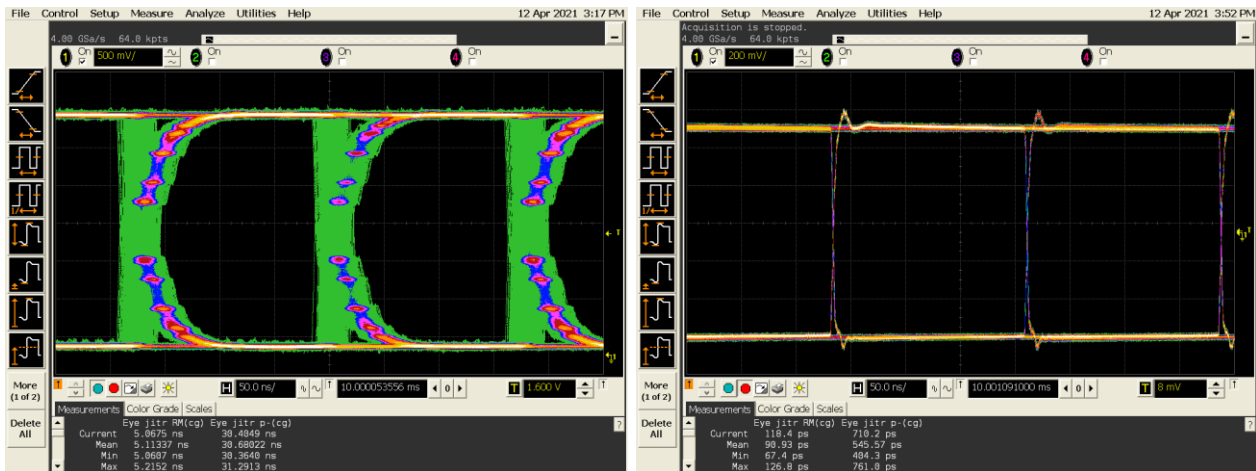

Eye diagram of the output S/PDIF signal. Generic HDMI audio extractor – left, Vanity<sup>PRO</sup>– right.

Effectiveness of the clock recovery system can be seen in the two oscilloscope waveforms above. There are waveforms with persistence enabled of the output S/PDIF signal – from a generic HDMI extractor on the left and the Vanity<sup>PRO</sup> on the right. The time base is delayed by 10ms to show accumulated phase noise using the colour grade. The difference in signal edge timing and definition can be clearly seen.

## 5.4 DSD Processing Engine

### 5.4.1 DSD to PCM Conversion

One of the key features of the Vanity<sup>PRO</sup> is the DSD signal processing and conversion to the PCM format. We have developed a high-quality DSD to PCM conversion algorithm to enable owners of stand-alone DACs to enjoy their favourite SACDs or DSD recordings in the highest quality possible. The conversion engine has user adjustable characteristics to slightly vary the frequency roll-off and subsequently the amount of residual ultrasonic noise inherent to the DSD format. The user can also control the output sample rate and bit depth.

The DSD to PCM conversion algorithm implemented in the Vanity<sup>PRO</sup> sets 0dB SACD level equivalent to -3dB(FS) PCM level. This approach preserves maximum quality, provides sufficient headroom for clipping-free signal peaks and over-modulation, and still does not unnecessarily reduce playback volume in comparison to PCM playback.

### 5.4.2 DSD and PCM Level Matching

The DSD to PCM conversion produces overall signal level 3dB lower compared to PCM playback. This is usually not an issue, but thanks to the precision volume control function, the output levels of DSD and PCM playback can be matched by attenuating PCM signal by 3dB. A positive side effect is that this helps to create sufficient headroom for inter-sample peaking with PCM material and DACs that don't provide such headroom by design.

### 5.4.3 DoP v1 output mode

The Vanity<sup>PRO</sup> can be also set to output DSD signal in so called DoP format (DSD Over PCM). This allows the user to send raw DSD material directly to a DoP compatible DAC. More details can be found here:

[http://dsd-guide.com/sites/default/files/white-papers/DoP\\_openStandard\\_1v1.pdf](http://dsd-guide.com/sites/default/files/white-papers/DoP_openStandard_1v1.pdf)

## 5.5 Down-Mix

To improve overall flexibility of the product to cover basic multichannel processing, one of the latest features added is the full-precision down-mix algorithm. It works with both PCM and converted DSD formats and user configurable speaker presence allows for virtually all down-mix scenarios. The algorithm preserves the overall signal level balance between channels.

### 5.5.1 7.1 to 4.0

For at least four speakers arranged in 4.0 configuration the down-mix algorithm can be described as below.

$$\begin{aligned} FL_{\text{mix}} &= 0.5FL + 0.25C + 0.25LFE \\ FR_{\text{mix}} &= 0.5FR + 0.25C + 0.25LFE \\ SL_{\text{mix}} &= 0.5SL + 0.5SBL \\ SR_{\text{mix}} &= 0.5SR + 0.5SBR \end{aligned}$$

To fit the mixed Center and Low-Frequency Effect channels into the front channels, the overall signal level is shifted by -6dB. The user can enable or disable the Centre, LFE and SB

channels in 7.1 speaker configuration. Disabled channels will automatically get downmixed as per the formula above.

### 5.5.2 7.1 to 2.0

For scenarios where multichannel audio is downmixed into just two channels, there is an option to also mix the rear channels into the front stereo.

$$\begin{aligned} FL_{\text{mix}} &= 0.25FL+0.125C+0.125LFE+0.25SL+0.25SBL \\ FR_{\text{mix}} &= 0.25FR+0.125C+0.125LFE+0.25SR+0.25SBR \end{aligned}$$

The presence of Surround channels (SR) option in the menu controls an additional level shift by another -6dB, so when disabled, the overall signal level is shifted by -12dB to allow the surround and surround back channels to be downmixed into the front stereo.

No additional signal normalization or scaling is applied. The user has the option to vary the channel mixing ratios using the per-channel volume trim. Since the down-mix processing is carried out with full precision, there is no adverse effect on sound quality such as reduced dynamics or worse noise figures.

## 5.6 Volume Control

A part of the processing engine is also full-precision per-channel volume control. It is used not only for DSD and PCM level matching, but it also gives the user full control of the overall output level to use the device as a digital preamplifier and individual channel volume trim.

The trim control is applied prior to the down-mix algorithm and this way the user can use the volume trim to adjust the mixing ratios of individual channels as mentioned above. With 0dB setting (maximum volume) the digital signal path is bit accurate.

The volume can be also controlled remotely via CEC protocol from either compatible HDMI source or sink device.

## 5.7 EDID Control

For scenarios with HDMI routing devices employed, such as HDMI splitters and multiplexers, it is sometimes necessary to change the EDID data to better suit the specific setup. For example, most HDMI splitters can copy EDID data only from one output port back to the input, making it difficult to match the device capabilities between the two output ports.

The user has the option to change certain audio and video EDID data on the RX port of the Vanity<sup>PRO</sup> to utilize the full bandwidth of the HDMI subsystem in terms of video transmission or restrict the default number of audio channels depending on the speaker setup.

## 5.8 Dielectric Barrier

There is a galvanic barrier put between the HDMI and the audio parts to limit the electromagnetic noise from the HDMI domain influencing the sensitive audio and clock circuits in the audio domain. Another advantage of this feature is the option to power the two functional parts independently from separate power supplies. The audio part can be powered from a high quality and low noise, possibly linear, power supply without the risk of being plagued by the noise from the switching regulators on the HDMI side.

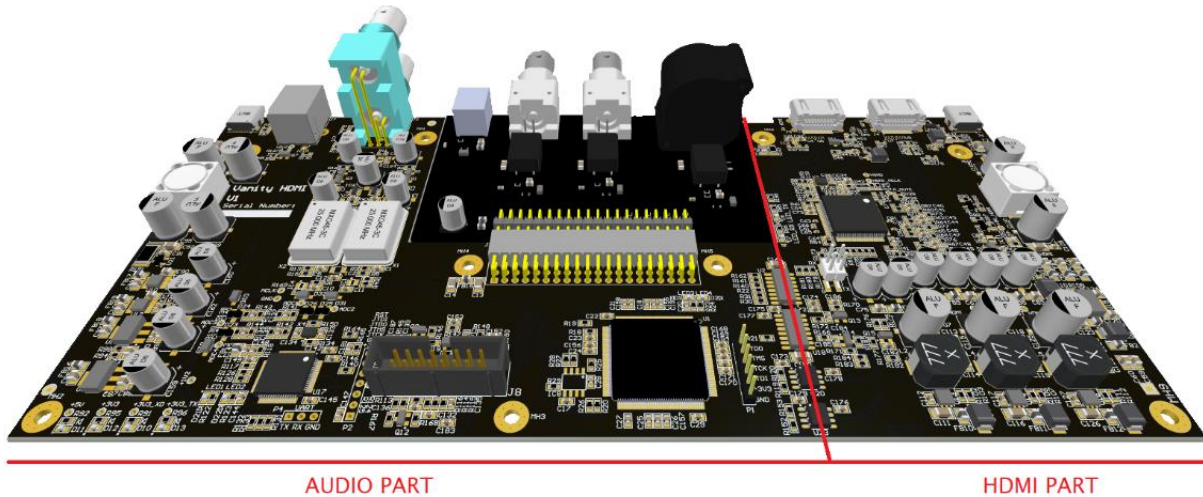

Dielectric domains of the Vanity<sup>PRO</sup> shown in the 3D model of the main PCB

## 5.9 Firmware Upgrades

All the digital audio processing is performed by a medium sized FPGA. The firmware for the FPGA is user-upgradeable, together with the main processor firmware and the HDMI subsystem firmware, to add new features and functionality in the future.

## 6 Menu system

The menu system is structured into several screens. Some screens are used for monitoring of the HDMI stream and incoming audio signal properties, while other are used to set the system and audio processing parameters.

### 6.1 Home Screen

The home screen provides basic overview of the HDMI link status and digital audio properties.

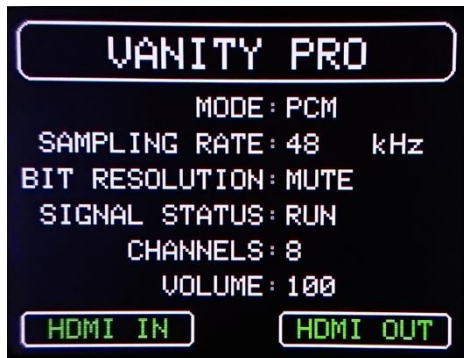

**MODE:** Indicates whether the incoming audio format is PCM or DSD.

**SAMPLING RATE:** Indicates incoming sampling rate. Valid sampling rates are: 44.1, 48, 88.2, 96, 176.4 and 192kHz. The sampling rate indicator also shows the status of the clock recovery system. When the algorithm is actively locking onto the incoming clock rate, the indicator turns orange.

**BIT RESOLUTION:** Indicates detected bit resolution in the range between 10 and 24 bits and MUTE when no valid bits are present. The bit depth detection algorithm monitors the real number of bits used (continuously changing). It is possible that the detected bit resolution sporadically changes during playback depending on the actual signal conditions and playback method. This applies primarily to compressed audio sources.

**SIGNAL STATUS:** Indicates the status of the incoming audio signal, RUN or STOP.

**CHANNELS:** Indicates number of valid channels in the range from 2 up to 8.

**VOLUME:** Indicates the currently set volume level in the range from 0 to 100.

**HDMI IN and HDMI OUT:** Indicate whether a HDMI link is established on the input or the output connector. Red colour indicates no HDMI connection. Green colour indicates established HDMI link.



When adjusting the volume via CEC, a large volume indicator appears in the menu screens for duration of the change. The volume is adjustable from the menu as well remotely via CEC. The volume setting is stored in non-volatile memory upon switching the unit into stand-by mode and restored upon power on.

## 6.2 Audio Setup

In this screen the user can configure several parameters of the DSD to PCM conversion algorithm, DSD output mode and output volume.

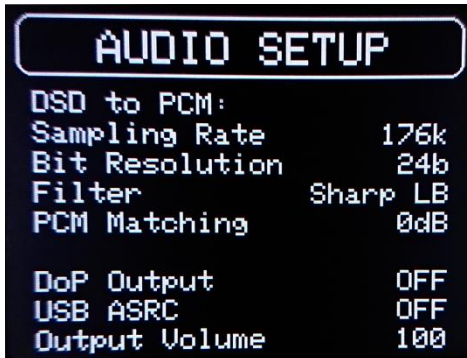

**Sampling Rate:** Sets the output sampling rate for DSD to PCM conversion. The options available are 88.2 and 176.4kHz.

**Bit Resolution:** Sets the output bit depth for DSD to PCM conversion. The options available are 16 and 24 bits. The 16-bit option can be useful for owners of so-called non oversampling (NOS) DACs or older devices designed to accept 16-bit word length only. In all other cases the 24-bit options should be selected.

**Filter:** Sets the DSD to PCM conversion filter characteristics. There are 4 options available. Sharp HB, Slow HB, Sharp LB and Slow LB. See the following paragraph for filter details.

**PCM Matching:** Enables or disables the PCM and DSD output level matching function. With 0dB setting, PCM is passed through bit accurate without attenuation. With -3dB setting, the PCM material gets attenuated by 3dB to match the output level from the DSD to PCM converter.

**DoP Output:** Enables or disables raw DSD output in the DoP format. Use only if your DAC can accept DoP signal.

**USB ASRC:** Enables or disables the asynchronous resampling function on the USB Audio output module. This parameter has no effect with any other output option.

**Output Volume:** Sets the fixed level of the output signal. The range is from 0 to 100 in 100 0.5dB steps. This renders the usable attenuation range from -50dB to 0dB. Select 100 (0dB) for bit accurate signal path with no attenuation.

### 6.2.1 Filters Characteristics

There are four conversion filter characteristics available in the Vanity<sup>PRO</sup>. The filters differ in their steepness and the amount of attenuation of the ultrasonic noise. All four characteristics can be used when the output sampling rate is set to 176.4kHz and only two with 88.2kHz. The filters optimized for 88.2kHz output sampling rate have “LB” suffix for “Low Bandwidth” and filters optimized for 176.4kHz output sampling rate have “HB” suffix for “High Bandwidth”. The frequency plots below show output spectrum of DSD test signal with 1kHz tone at 0dB converted to PCM 24bit and 176.4kHz. Typical bumps if the DSD noise floor can be observed in the audio frequency band.

#### Sharp LB

This filter optimized for 88.2kHz output sample rate has sharp roll-off with cut-off frequency approximately 20kHz. Chose this filter for high attenuation of the ultrasonic noise.

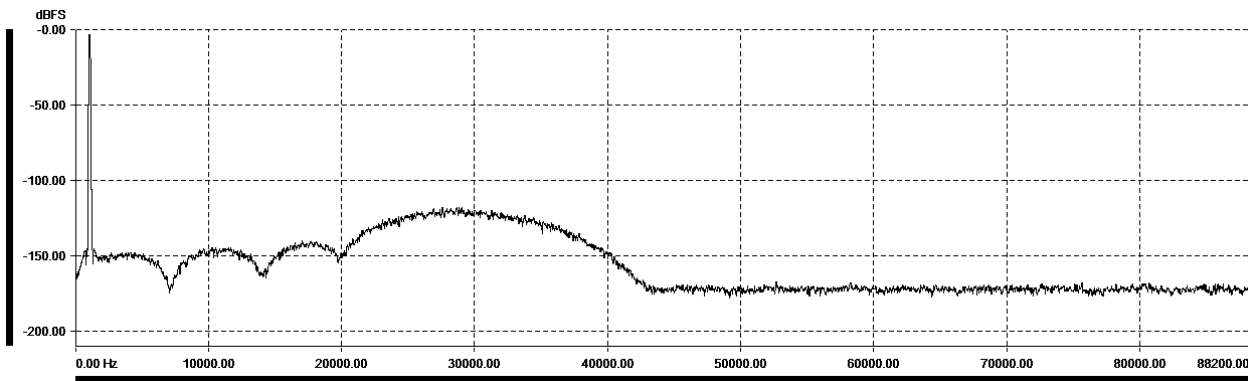

#### Slow LB

This filter optimized for 88.2kHz output sample rate has slow roll-off with cut-off frequency approximately 25kHz. Chose this filter for better transient response with slightly higher level of the ultrasonic noise.

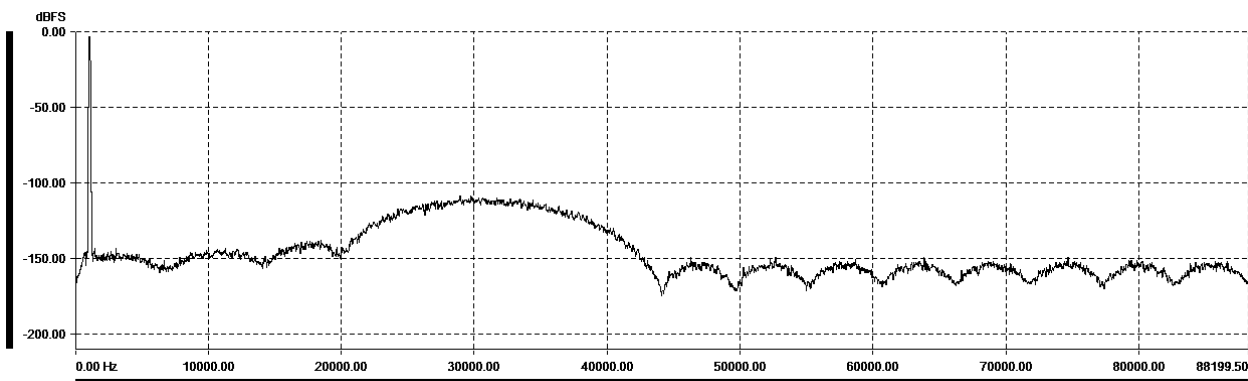

### Sharp HB

This filter optimized for 176.4kHz output sample rate has sharp roll-off with cut-off frequency approximately 44kHz. Chose this filter for high bandwidth and high attenuation of the ultrasonic noise.

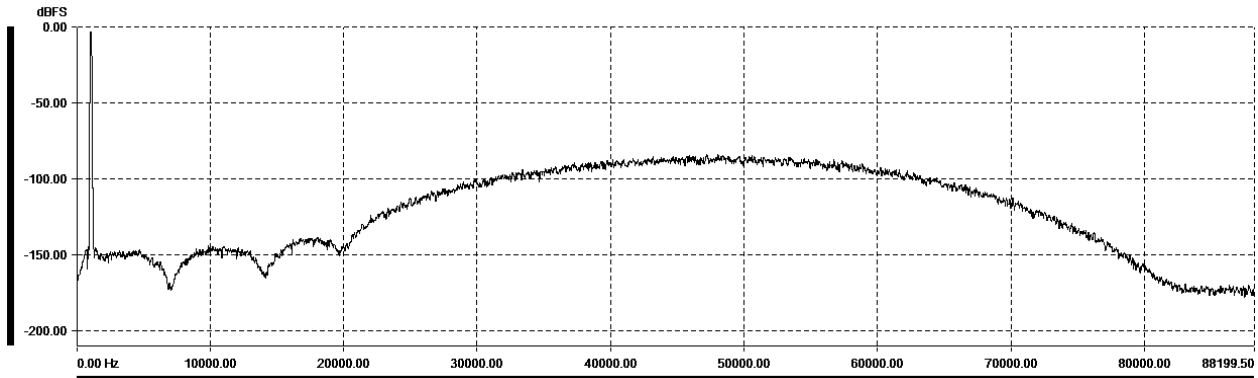

### Slow HB

This filter optimized for 176.4kHz output sample rate has slow roll-off with cut-off frequency approximately 55kHz. Chose this filter for the best transient response at the expense of the highest level of the ultrasonic noise.

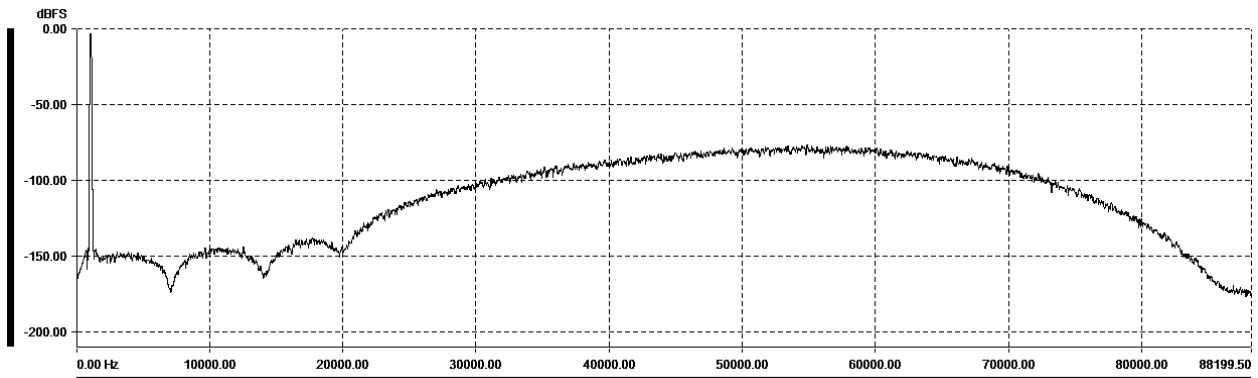

There is no general rule for which filter characteristic is the best. The best sounding filter characteristic should be selected by practical listening and evaluation of sonic qualities for each specific audio chain configuration. With a very linear audio system with sufficient analogue path bandwidth the Slow HB filter at 176.4kHz would be expected to be preferred as it maintains the highest level of DSD bandwidth (including the ultrasonic noise) and the best transient response.



### 6.3 Speaker Setup

The speaker setup allows the user to configure the downmix algorithm and output level mapping of the second output pair containing the Center and LFE channels.

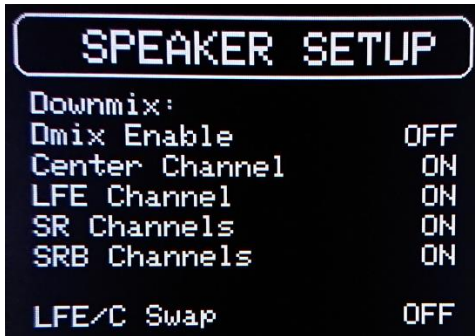

**DMix Enable:** Enables or disables the downmix algorithm. If downmix is disabled, the signal path is bit accurate. If downmix is enabled, all channels are attenuated by 6dB to create processing headroom.

**Center Channel:** Sets the presence of the Center channel. If the presence is OFF, the channel content is downmixed into the front channels.

**LFE Channel:** Sets the presence of the LFE channel. If the presence is OFF, the channel content is downmixed

into the front channels.

**SR Channels:** Sets the presence of the Surround channels. If the presence is OFF, the channels content is downmixed into the front channels and additional 6dB attenuation is triggered to increase processing headroom and keep the overall balance of all channels constant.

**SRB Channels:** Sets the presence of the Surround Back channels. If the presence is OFF, the channels content is downmixed into the Surround channels.

**LFE/C Swap:** In firmware V4 the output mapping of the second stereo pair has been changed to Center channel being transmitted in the left channel of the stereo pair and the LFE channel in the right stereo channel. The swap function allows the user to easily remap the Center and LFE channels to the previous configuration – LFE in left and Center in right channel.

## 6.4 Speaker Trim Setup

Additional feature of the volume control unit is per-channel volume trim adjustment. In this screen the trim values can be independently adjusted for all channels.

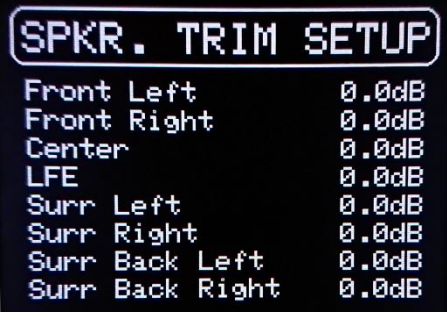

SPKR. TRIM SETUP	
Front Left	0.0dB
Front Right	0.0dB
Center	0.0dB
LFE	0.0dB
Surr Left	0.0dB
Surr Right	0.0dB
Surr Back Left	0.0dB
Surr Back Right	0.0dB

All channels can be trimmed in the same way. The adjustment range is  $-7.5\text{dB}$  to  $0\text{dB}$  in  $0.5\text{dB}$  steps. When all channels are set to  $0.0\text{dB}$  the signal path is bit accurate.

The speaker trim adjustment is applied prior to the downmix processing block. This way the mixing ratios between the channels can be modified.

## 6.5 HDMI Setup

All setting related to the HDMI subsystem are available in this screen.



**CEC Standby:** Enables or disables remote power ON and power OFF control over CEC bus from either HDMI source or sink device.

**CEC Volume:** Enables or disables remote volume control over CEC bus from either HDMI source or sink device.

**ARC:** Enables or disables the Audio Return Channel functionality. This requires compatible HDMI sink and its correct configuration.

**HDMI Mode:** Sets the operation mode of the HDMI interface. Two options are available: Extractor and Repeater. The default mode is Extractor, and this setting should be used for normal operation. In the Repeater mode, the HDMI stream is passed through as is, including the audio data. Also, the EDID data are passed through from the HDMI TX port back to the HDMI source, bypassing the internal EDID. The Repeater mode should be used only for debugging the HDMI connectivity as it does not add any functionality over the default Extractor mode. When the mode is changed the Vanity<sup>PRO</sup> automatically restarts with the new settings.

**HDMI in Standby:** Enables or disables the HDMI subsystem to remain functional in standby mode. This setting might be useful if video pass-through functionality is required even in standby mode of the Vanity<sup>PRO</sup>.

## 6.6 EDID Setup

The default EDID parameters on the RX port can be modified in this screen.

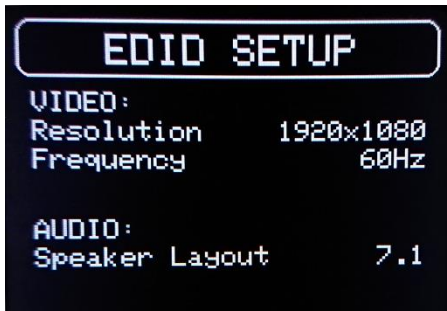

**Resolution:** Selects maximum supported video resolution. Two settings are available 1920x1080(FHD) and 3840x2160(4k).

**Frequency:** Selects maximum video frame frequency (refresh rate). Available settings are 25Hz, 30Hz, 50Hz and 60Hz.

**Speaker Layout:** Selects the number of supported channels in speaker layout schemes as per CEA-861-D standard. Available settings are: 2.0, 2.1, 4.0, 4.1, 5.1 and 7.1.

## 6.7 System Setup

The system setup allows the user to configure the screen, stand-by LED, and synchronization clock outputs.

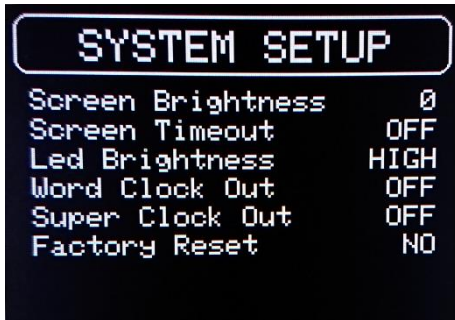

**Screen Brightness:** Sets the screen brightness in the range 0–100. 0 is minimum brightness and 100 is maximum brightness.

**Screen Timeout:** Sets the time for turning the screen and the backlight off to minimize light disturbance from the screen in dark environments. Turning the knob will turn the screen back on. The settings are 5s, 15s, 30s and OFF.

**LED Brightness:** Sets the brightness of the stand-by LED.

Three settings are available – Low, Mid and High.

**Word Clock Out:** Enables or disables the Word Clock output.

**Super Clock Out:** Enables or disables the Super Clock output.

**Factory Reset:** Brings the unit to the original settings.

## 6.8 HDMI AV Info

In this screen the user can see various parameters of the received HDMI stream as detected by the HDMI interface. The data is extracted from the HDMI Audio Info Frame as per CEA-861-D.

```

HDMI AV Info
AUDIO:
Channel Count      8
Channel Mapping    0x13
Level Shift        0dB
VIDEO:
Format             STD
Colour Depth       -
Colour Format       YCrCb444

```

**Channel Count:** Indicated number of channels in the “Audio Channel Count” (CC bits). Value can range from 2 to 8.

**Channel Mapping:** Indicated number of “Channel Configuration” (CA bits) in hexadecimal format. Please refer to CEA-861-D section 6.6 for details.

**Level Shift:** Indicated value of attenuation as “Level Shift Value” (LSV bits) converted to dB. Value can range from 0dB to 15dB.

**Format:** Indicated current video format. There are three possible values – STD for Standard, EXT for Extended covering all 4Kx2K resolutions, and 3D covering all 3D formats.

**Colour Depth:** Indicated Colour Depth (CD bits). There are five possible values – 24, 30, 36 and 48 bits per pixel and “-“ for not indicated.

**Colour Format:** Indicated Colour Format (Y bits). There are three possible values – RGB, YCbCr 4:2:2 and YCbCr 4:4:4.

## 6.9 Audio Meters

For quick overview of the audio signals presence and incoming audio signal levels, the Vanity<sup>PRO</sup> features an 8-channel audio level meter. Each channel has a dedicated meter with the range from 0dBFS down to -48dBFS and tri-colour grade. The channel names are coded with standard abbreviations. The additional names in the brackets follow the naming convention of the CEA-861-D standard.

- FL – Front Left
- FR – Front Right
- C – (Front) Center
- LFE – Low Frequency Effect
- SL – Surround (Rear) Left
- SR – Surround (Rear) Right
- SBL – Surround Back (Rear Center) Left
- SBR – Surround Back (Rear Center) Right

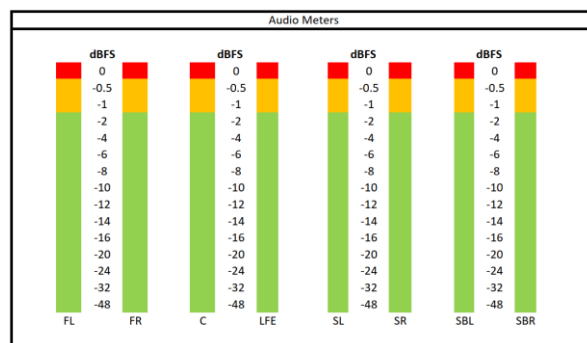
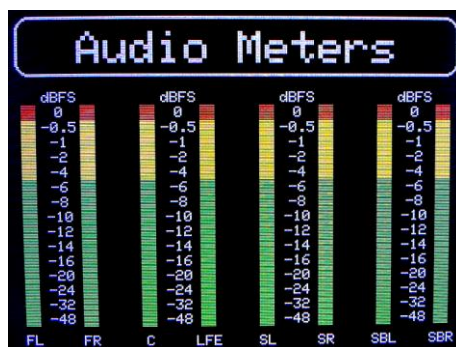

Audio Meters screen and prototype showing the colour-grading of the meters

## 6.10 System Status

This screen shows the overall system status, health, and operational parameters.

```

SYSTEM STATUS
POWER
MAIN Voltage: 4.87 U
MAIN Current: 516 mA
XO Voltage : 3.25 U
TX Voltage : 3.26 U
AUDIO
Status : RUN
Mode : PCM
Frequency : 48 kHz
UCMO : 24.57 MHz
XO Control : 1.651 U
Buffer : 60 %
HW
HDMI : OK
FPGA : OK
DISPLAY : OK
HDMI
RX Status : ACTIVE
TX Status : ACTIVE
Audio Mode : PCM
Frequency : 48 kHz
ARC : DISABLED
PRODUCT
Vendor : Audiopraise
Model : Vanity PRO
Serial No. : APUP6535
HW Version : 1
SW System : 4
SW FPGA : 4
SW HDMI : 35

```

**POWER:** Shows internal voltage measurements of various voltage rails and Audio side power input current.

**AUDIO:** Shows various audio parameters which are available in the home screen as well as oscillator selection, oscillator control voltage and audio buffer utilization.

**HW:** Shows internal health checks for the key components – HDMI interface, FPGA, and the screen.

**HDMI:** Shows the ID information and status of the HDMI interface.

**PRODUCT:** This section shows the product related information, such as serial number, hardware version and firmware (SW) version. Information from this section should be always provided when support is required.



## 7 Software Update

The Vanity<sup>PRO</sup> is built on a completely programmable processing and control platform utilizing a medium size FPGA and a 32-bit processor. New features and functionality can be added at any time and the firmware can be upgraded by the user through an easy-to-use Windows PC app.

To update the software, the user must put the unit into firmware update mode and follow a few simple steps:

- Power off or unplug the power cable of the audio side.
- Press and hold the encoder knob.
- Apply/connect power to the audio side.
- Wait 2–3 seconds before releasing the knob.
- Connect USB–B cable to the Service port.
- Verify that the unit reports itself in the device manager as “STM Device in DFU Mode”.

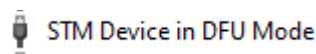

If not, please install STM DFU drivers provided in the Resources page on the AP web.

- Run the Audiopraise Firmware Loader. It requires MS Visual C++ 2015–2022 Redistributable to run. Check the Vanity<sup>PRO</sup> device is correctly detected.

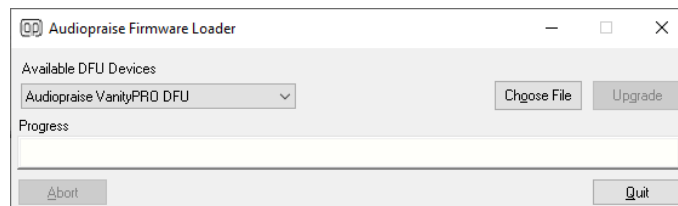

- Choose the new firmware file and verify the file has been correctly loaded. Then hit the Upgrade button.

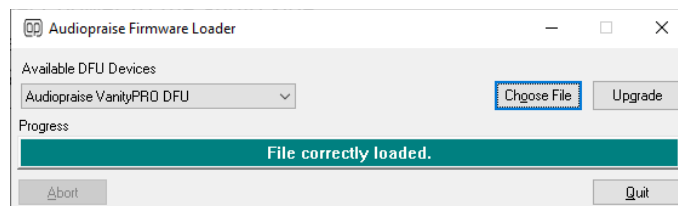

- Wait for the firmware to load. The process has several stages to upgrade all subsystems of the unit. Progress of some stages is reported on the screen. Once the new firmware has been verified, close the Loader, unplug the USB cable, and power cycle the unit.

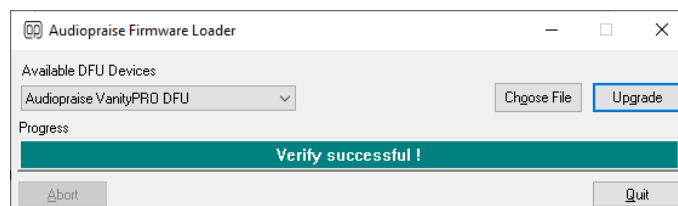

- The Vanity<sup>PRO</sup> now should start with the new firmware. You can verify the firmware version in the System Status screen.

## 8 Troubleshooting

The Vanity<sup>PRO</sup> implements a robust system of its own health monitoring. The status and functionality of all major components is continuously monitored and reported in the System Status screen. Should the user experience any non-standard or unexpected behaviour, diagnosing the potential issue is easy and straight forward.

Before a fault is suspected, the user should make sure that the unit is correctly installed, the power, HDMI and digital audio cables are properly connected and secured (BNC connectors). Also, the HDMI source should be checked for correct operation and configuration. The Vanity<sup>PRO</sup> might not be receiving the expected audio format, sampling frequency or any audio at all due to incorrect configuration of the HDMI source – universal player, streamer, or computer. With computers, the HDMI audio support is sometimes restricted or non-existent due to software drivers. The Vanity<sup>PRO</sup> has been extensively tested with many different Blu-ray and universal players with positive results. With Windows based PCs, getting the HDMI audio to work sometimes required trial & error experiments with HDMI audio drivers and settings.

The table below contains a non-exhaustive list of some issues the user might experience, mainly due to large variability in device configurations the Vanity<sup>PRO</sup> can be used with.

Issue	Possible cause	Solution
HDMI Error reported at start up.	HDMI part has no power.	Check power connection for the HDMI part and reboot the unit.
Audio sampling frequency indicator remains orange.	HDMI source signal is unstable or outside of frequency stability specifications.	Use different HDMI signal source.
No audio from downstream DAC, or DAC unlocked.	SPDIF/AES cable not connected or audio sampling frequency too high.	Check the connections. Set DSD to PCM sampling frequency to 88.2kHz
Occasional dropouts in reproduced audio	DAC with ESS chip might be too sensitive to frequency adjustments. See <i>Note 1</i> .	Consult the user manual of your DAC for DPLL adjustment.
Error message “missing mfc140.dll” with the AP Firmware Loader	MS Visual C++ Redistributable libraries not installed.	Download and install MS Visual C++ Redistributable 2015-2022

*Note 1:* The user might experience occasional dropouts in the audio signal with a DAC based on a ESS (Sabre) DAC chip. The jitter attenuation function of this chip called DPLL has several settings and with certain combinations of the DAC’s local oscillator and the DPLL setting the DAC chip may momentarily unlock when the Vanity<sup>PRO</sup> is adjusting its own audio clock. Many ESS chip-based DACs have the DPLL settings exposed to the user and using a lower DPLL setting usually fixes the problem.

## 9 Specifications

### HDMI

- Version 2.0a
- 1x input and 1x output for pass-through + ARC

### Digital Audio Outputs

- 8 or 2 channel (stereo) output module options
- 4xBNC/RCA/XLR for 8-channel output
- 1xXLR + 1xBNC + 1xRCA + 1x TOSLINK for 2-channel output
- protocols: S/PDIF (IEC958 / EIAJ CP1201), AES/EBU and TOSLINK
- transformer isolated outputs
- output impedance: 75Ω for BNC/RCA and 110Ω for XLR
- linear PCM 16/24 bits
- supported sampling rates: 44.1 / 48 / 88.2 / 96 / 176.4 / 192kHz

### S/PDIF Re-clocking

- 2x custom low jitter on-board VCXO
- digitally controlled frequency tuning,  $f_c \ll 1$ Hz
- ultra low-noise power regulators for VCXO and TX circuits

### High Quality DSD to PCM Conversion

- custom developed Zero Alias Linear Phase Filter
- 37bit arithmetic / 47bit accumulator
- output sample rates: 88.2kHz / 176.4kHz
- 4 selectable DSD to LPCM filter characteristics
- full precision 4.0 DSD down-mix option
- DoP v1 output encoding of raw DSD

### Full Precision Volume Control

- less than 0.001dB gain error
- bit accurate volume bypass at 0dBFS
- TPDF dithering
- PCM and DSD level matching and channel trim

### Synchronization outputs

- Word-clock output: BNC, 50Ω impedance, 44.1 / 48 / 88.2 / 96 / 176.4 / 192kHz
- Super-clock output: BNC, 50Ω impedance, 22.5792MHz or 24.576MHz

### User Configurable Functionality

- DSD to LPCM output sampling rate: 88.2kHz / 176.4kHz
- DSD to LPCM output bit depth settings: 16 / 24bit
- PCM and DSD output level matching enable / disable
- Multichannel down-mix enable / disable individual channels
- DoP v1 output encoding enable / disable
- 4 user-selectable DSD to LPCM filter characteristics
- Adjustable output gain (volume) with 0.5dB step for each channel

### HDMI and Audio Monitoring & System Diagnostics

- Monitoring of HDMI stream parameters and EDID control
- 8-channel audio level metering
- Comprehensive system health diagnostics

### Power

- separate power for HDMI and audio sides via USB-C connectors
- 2x DC input 5V / 1A

### Dimensions & Weight

- w/d/h: 266/183/65 mm, including the output connectors
- weight: 1kg

## 10 Revision History

Date	Version	Description
16.10.2021	1.0	Initial release
25.10.2021	1.1	Added Troubleshooting table
18.11.2021	1.2	Added Troubleshooting info related to ESS DACs
22.06.2022	3.0	Added description of new functions in firmware V3
12.12.2022	4.0	Added description of new functions in firmware V4
20.02.2023	5.0	Added description of new functions in firmware V5

## 11 Disclaimer

The product has been designed and manufactured using high quality materials in accordance with best practices in the industry and international harmonized safety standards. Audiopraise accept no responsibility for any damage or injury caused by incorrect installation, use or operation of the product.